



AFINIA LABEL

L301 LABEL PRINTER

Quick Setup and Installation Guide

For more detailed information, please refer to the **User Guide** installed on your PC.

Unpack:



1 Remove Tape

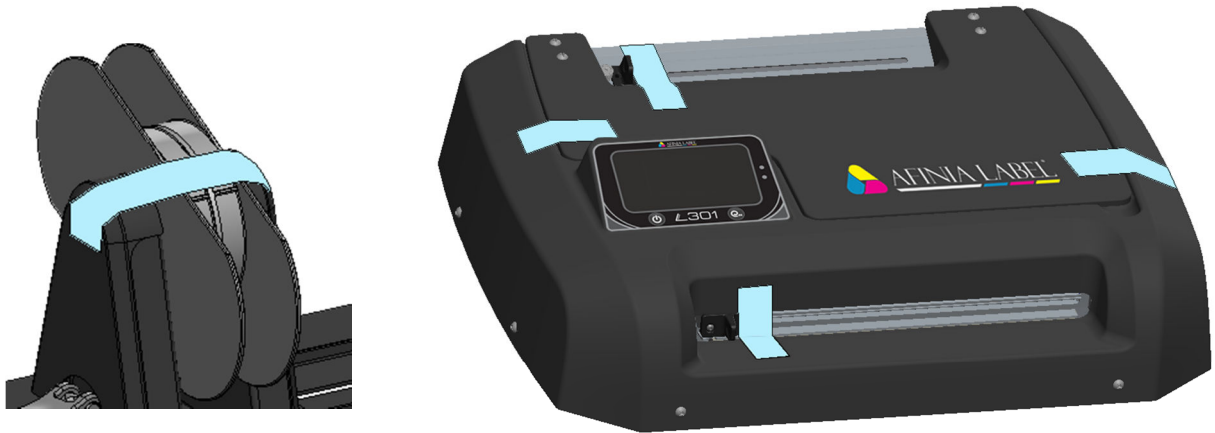

2 Connect Power

a

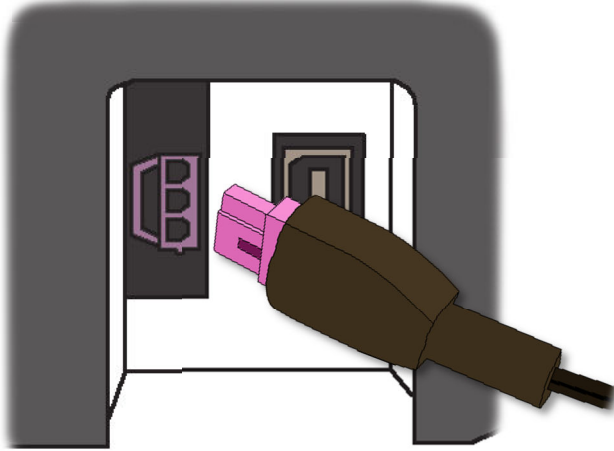

b



3 Install Ink Cartridges

a

Open Ink Cartridge Access Door

b

Remove plastic tape from cartridges using pull tab

c

Lift cartridge latches

d

Carefully insert ink cartridges
Must be Afinia ink cartridges!

e

Lower cartridge latches until they click

f

Close Ink Cartridge Access Door

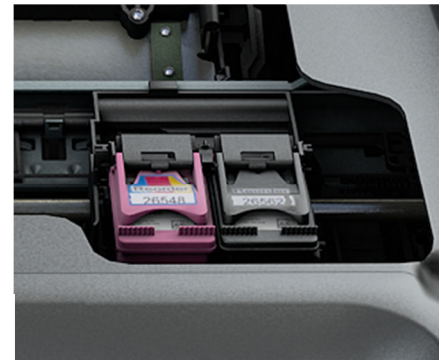

c



d



e

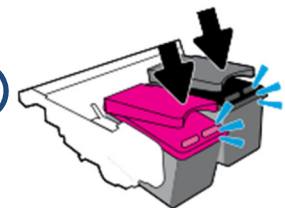

4 Install Printer

a

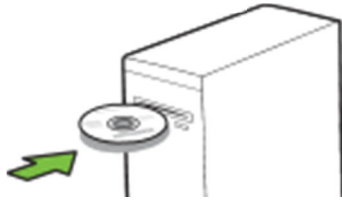

b

Run **Setup.exe**

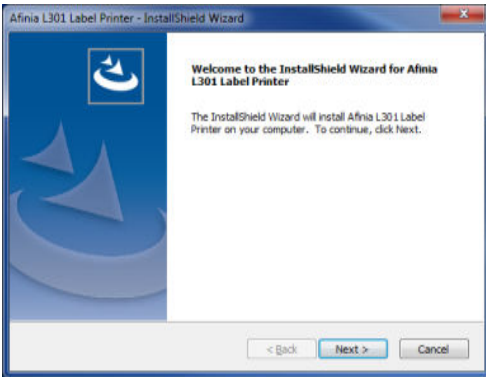

c

Click **Install** (will see this 3 times)

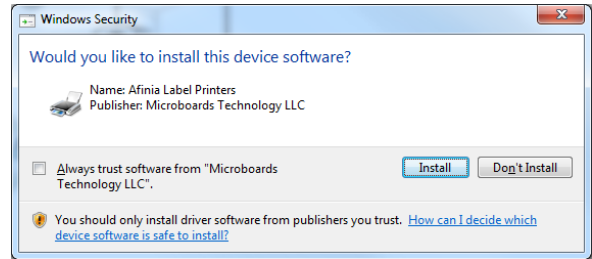

d

Connect printer to PC

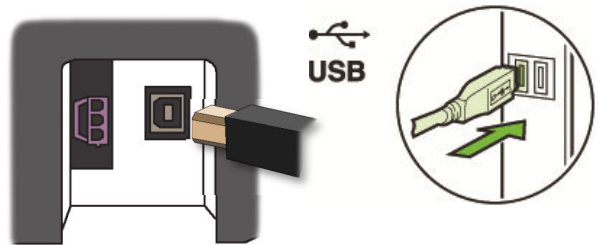

5 Install Unwinder and Load Media

a

Connect Unwinder to Printer

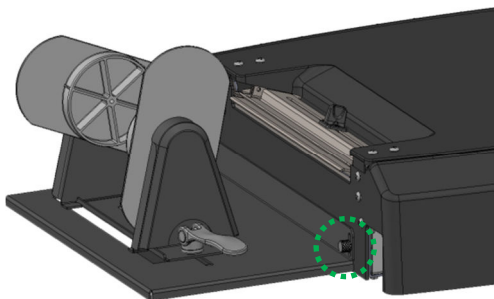

2 thumbscrews included for installation (1 shown)

b

Lift unwinder lever on adjustable holder to unlock

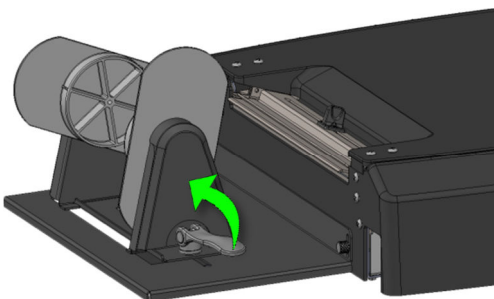

c

Place roll on fixed holder, slide adjustable holder onto core, lock lever down

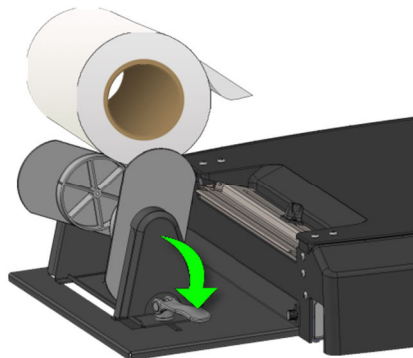

d

Insert stock into input slot

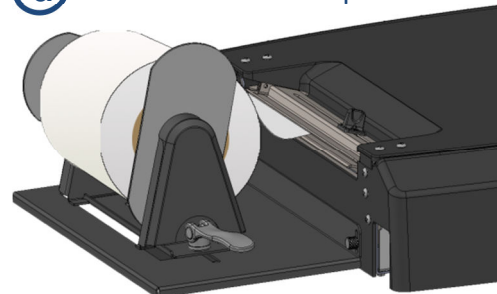

Push stock in until auto-feed begins, then adjust Paper Guide

Control Panel LEDs

The LEDs on the control panel indicate a number of printer states:

Green LED	Red LED	Display	
Off	Off	Off	1. Power cable not plugged in 2. Plugged in, but power button not pressed
Slow Blink	Fast Blink	Off	Power cable was just plugged in
Always On	Fast Blink	On	Printer powering up
Slow Blink	Off	On	Printer on, no stock loaded
Always On	Off	On	Printer on, stock loaded (ready)
On or Blink	Always On	On	Cutter not in Home position (fully left or right) Printer is paused in this state
On	Blink	“Printing...”, “Cancelling...”	Incorrect Media type; cut required. Perform cut and move cutter to home position. After cut, media will unload. Load correct media and touch OK to print or touch Cancel
Slow Blink	Blink	“Out of Paper”	Cut required. Perform cut and move cutter to home position. After cut, media will unload. Load media and touch OK to print or touch Cancel

For technical questions or support issues, contact Afinia Label Technical Support:

PH: 952-279-2643

support@afinia.com

www.afinialabel.com/support

Please have the Serial Number of your Afinia Label L301 Label Printer available when contacting Technical Support.