

LABEL APPLICATOR

A200



User Manual

Version 3.1



Table of Contents

Introduction.....	5
Using the applicator	5
Included Items.....	6
Specification	6
Noise information.	6
Equipment Description	6
General safety instructions	8
Workplace Environment	8
Specific safety instructions.	8
Operating instructions.....	9
Setup	9
Preparing the applicator	9
Turning on the applicator	11
How to determine the Offset Stop value.....	11
Working with the menu and changing parameters.....	12
Labeling	12
Adjusting display contrast and brightness	12
Adjustment of the label sensor	13
How to determine the Offset Stop value.....	14
How to determine the Offset Stop 1 value	15
How to determine the Offset Stop 2 value	16
Memory Locations.....	17
Working with the menu and changing parameters.....	17
ONE LABEL mode parameters.....	18
TWO LABEL mode parameters	19
How to determine the distance between labels	20
Maintenance and cleaning.....	21
Service	21
Transportation	21
Warranty.....	22
Regulatory Details	23
Technical Support.....	24

The following symbols are found in this manual.

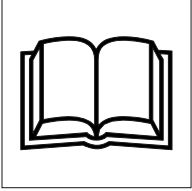

Read the User Manual!



Follow safety warnings and instructions!



Protect yourself from electric shock. Use Caution!

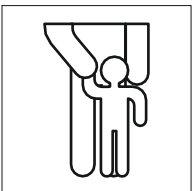

Keep children away from the machine while in operation!

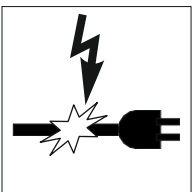

Risk of electric shock when a power cord is damaged!



Dispose of the packaging and hardware in accordance with environmental regulations!

Introduction

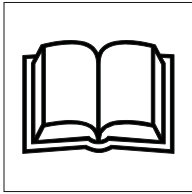

Before using the applicator for the first time, get acquainted with the functions of the machine and its operation. Be sure to read and follow the operating instructions in this manual. If other parties will be using the applicator, be sure to include all documentation.

Using the applicator

The machine is designed to apply one or two labels (front side and back side) on cylindrical containers of different diameter and length. The sides of the container must be smooth. Labels should be on one roll, and in the case of front and back labels - arranged in the correct order.

Place the container horizontally on the rollers, between the adjustable guides. Press the start button or foot pedal. The machine adheres the label as it rotates the container. After the rollers stop and the label is applied, the container is manually removed from the applicator.

Any other use is not authorized and generates significant risks of accidents. The manufacturer accepts no responsibility for faults and damages caused by incorrect use of the applicator.

Overcurrent protection is provided by fuses built into the machine. Their replacement should be performed by qualified personnel.

Attention!



Do not use containers that are outside the specifications listed below!

Do not use damaged containers or containers that have irregular shapes.

Do not label full containers which are not properly sealed!

There is a danger of electric shock!

Do not use labels that are outside the specifications listed below!

Make sure power is off when loading labels and when doing any maintenance or cleaning!

Do not cover the ventilation openings on the machine!

Be careful not to spill liquid on the machine!

Do not insert objects into the openings on the machine! There is a danger of electric shock!

Do not place your hand or fingers on the shafts of the machine when it is operating! There is a danger of injury!

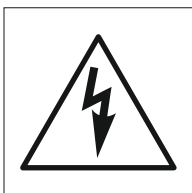

Attention!

In case of electric shock, immediately disconnect the power cable from the machine.



Included Items

- 1 A200 Label applicator
- 1 power cable
- 1 'Start pedal' with connection cable
- 1 operation manual.

Specification

Supply voltage:	North America – 100V - 120V AC, 60 Hz Europe, Asia, Middle East - 220V AC, 50Hz
Power consumption:	50W, <100VA
Electrical connection:	Grounded AC power cable
Dimensions:	W 365mm, H 245mm, D 330mm W 14.4in, H 9.5in, D 13 in
Machine weight:	12kg (26.5 lbs)
Diameter of container:	25 to 160mm (1 to 6.3 inches)
Length of container:	80 to 240mm (3.15 to 9.45 inches)
Diameter of label roll:	<203mm (8 inches)
Core size:	46 to 76mm (1.8 to 3 inches)
Label width:	25 to 150mm (1 to 6 inches)
Label length:	25 to 500mm (1 to 19.68 inches)
Label Gap:	>2.5mm (.1 inches)
Dispensing speed:	0.1m/sec (4 in/sec)

Noise information.

Acoustic pressure level <70dB (A)
Noise level <70dB

Equipment Description

See Figure 1.1 and Figure 1.2

- | | |
|---------------------------------------|---------------------------|
| 1. Supporting shaft | 10. Control panel |
| 2. Driving shaft | 11. Start button |
| 3. Guides (detents) | 12. Sensor for labels |
| 4. Pull shaft | 13. Power switch |
| 5. Pressing shaft | 14. Power supply coupling |
| 6. Clamping mechanism | 15. Driving shaft |
| 7. Guides (detent) for the label roll | 16. Label roll guides |
| 8. Roll label holder | 17. Foot pedal connection |
| 9. Brake for the label roll | |

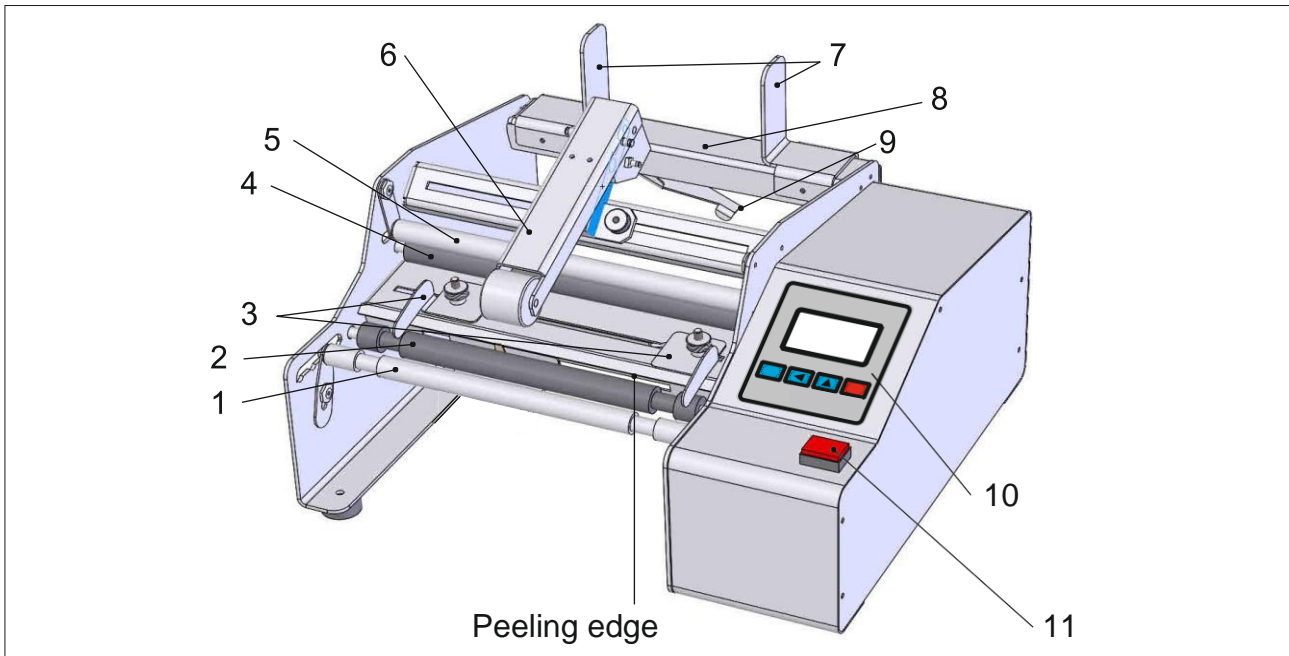

Figure 1.1

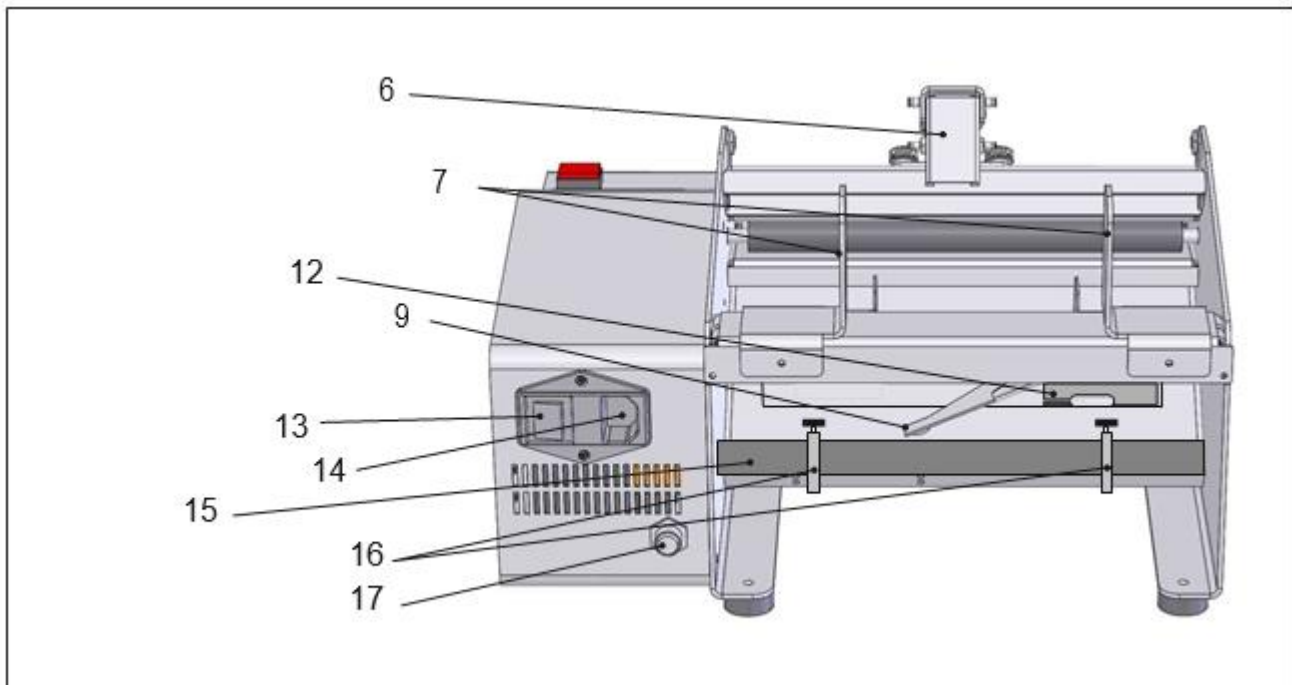

Figure 1.2

General safety instructions

Attention!

The following safety precautions must be observed when using electrical appliances to protect against electric shock, risk of injury and fire. Read all of these instructions before using the machine.



Workplace Environment



- Ensure there is good lighting in the work area.
- Do not use the applicator in humid conditions.
- Do not use the applicator in places where there is a risk of fire or explosion.
- Keep bystanders, especially children, away from the equipment when it is running.

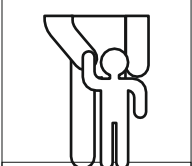

- Do not use the applicator for purposes other than those intended.
- Protect the power cable from heat and sharp objects.
- Carefully maintain your device.
- If you are not using the applicator, disconnect the power cable.
- Do not use the applicator if the power switch or power cable is damaged.
- Only use a grounded AC power cable.

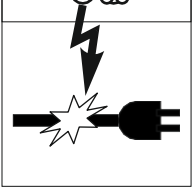

- Inspect the machine for any damage. Check that the moving parts function as designed and that there are no damaged parts. All parts must be installed correctly and meet all conditions to ensure proper operation. Damaged safety components and parts must be repaired or replaced by a certified technician, unless otherwise stated in the instructions of the operation manual.

Specific safety instructions.

The container to be labeled is inserted and removed manually. The labeling procedure is started by pressing the built-in 'Start' button, or by the external start pedal connected to the device.

- Do not insert a container while the applicator rollers are moving.
- Do not start the machine with a container that is incorrectly installed.
- Do not remove the container from the machine until the rollers have stopped.
- Failure to follow these instructions may result in injuries or damage.

Operating instructions



Attention!

Every operator working with the label applicator should be familiar with this user manual.

Setup

Place the applicator on a flat, horizontal surface larger than its base. You should provide space around the machine for maintenance, servicing and handling.

Install the power cord that is included with the applicator. Install the start pedal cable to the connector on the back of the applicator.

Preparing the applicator

The orientation of container (left - right) depends on the direction of the printed labels. The height of the clamping mechanism and the position of the support shaft are adjusted according to the diameter of the container. Adjust the detents (stoppers) so that the container is in the middle of the work area. Install the roll so that the labels unwind with the liner facing up. The position of the roll is fixed by the two magnetic stoppers (detents). The brake is positioned in the middle of the roll.

The pressure shaft is 'unlocked' by moving it forward. The label roll is loaded according to the picture below. The sensor is positioned so that the label roll fully covers the sensor area (narrow gap).

Sensor set up can be found on page 13. The beginning of the label (front - for two labels) is positioned next to the peeling edge. The pressure shaft is 'locked'. Label roll guides are positioned and fixed to the edges without squeezing it.

The Stoppers (detents) are installed to allow for the maximum size container. If a container smaller than 60mm is used, the stoppers can be adjusted, to allow for this.

1. Remove the thumb screws. There are two washers under the thumb screw. Be careful not to misplace the washers.

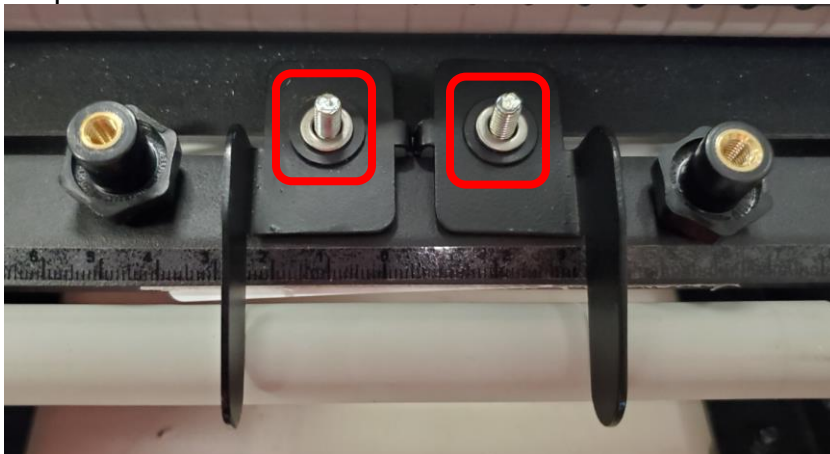

2. Lift the stoppers to remove them. There will be washers on the bolts. Leave these in place.

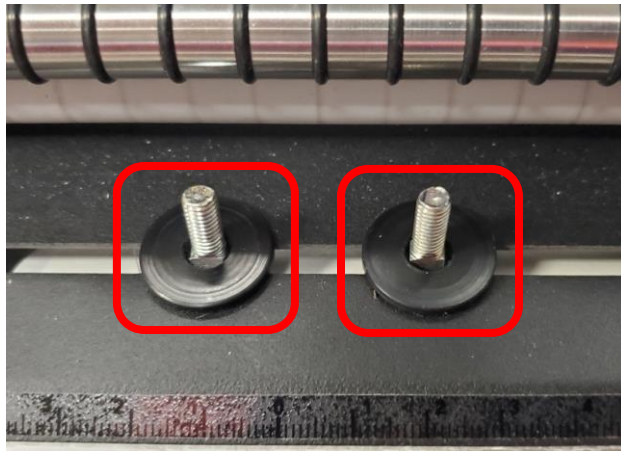

3. Install the stoppers, reversing their position. The tabs will be on the inside. Install the washers.



4. Install the thumb screws.



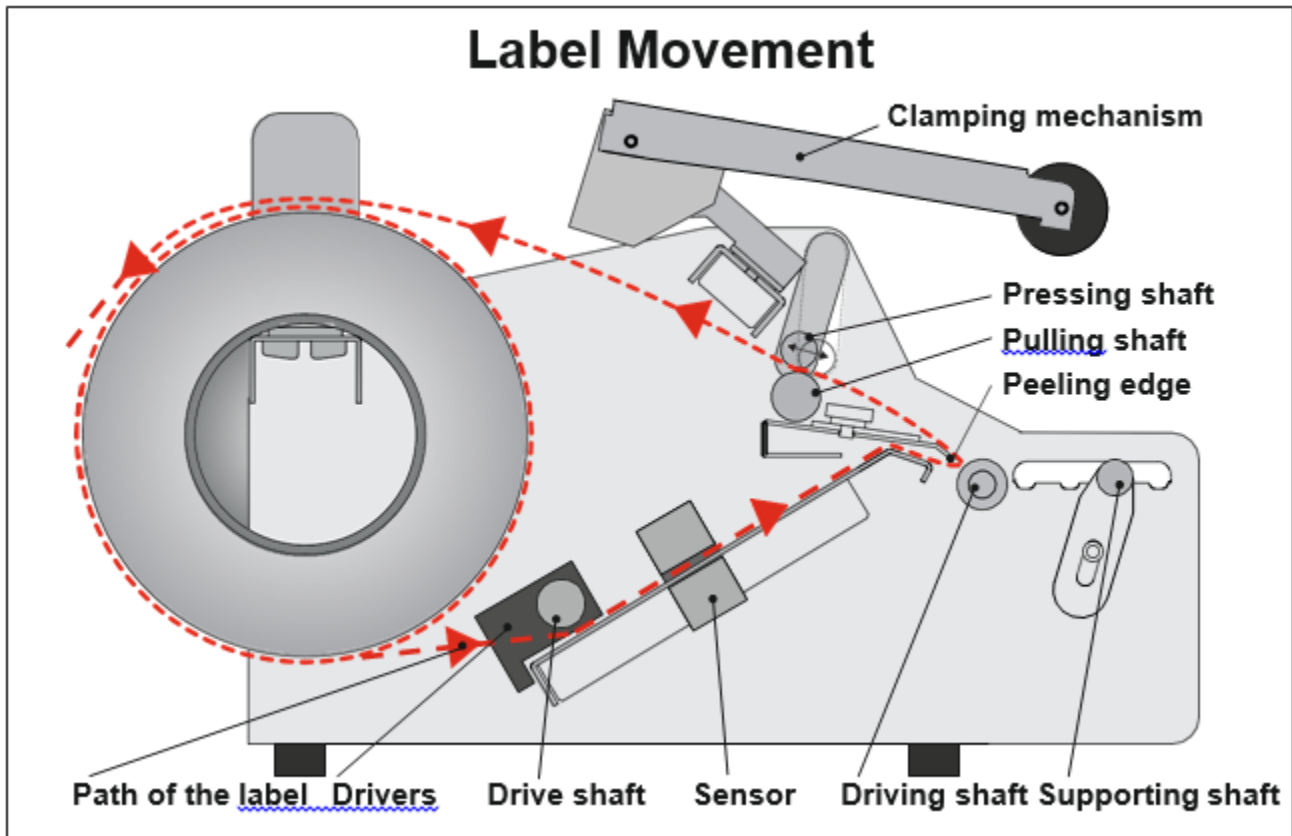

Turning on the applicator

Plug in the AC power cord to the back of the unit. Turn on the power switch. The unit will boot up to the main screen.

How to determine the Offset Stop value

The sensor which is reading the end of the label is located 100mm before the peeling edge and its position cannot be changed. This requires an 'Offset-stop' parameter to be entered for the single-label mode and 'Offset-stop 1' and 'Offset-stop 2' for the two-label mode. This parameter determines the proper positioning of the subsequent label to the peeling edge. The values depend on the length of the labels and the distance between them. Determine the offset and distance values prior to applying labels. The online tool to calculate the values can be found on our website, <https://afinialabel.com/calculate-a200>. This QR code will take you to the webpage.



When applying a single label, see page 14 to manually calculate the parameter value.

When applying two labels, see pages 15 and 16 to manually calculate the parameter values. If the front label is less than 100mm and the back (rear) label is larger than 100mm, the back (rear) label must be applied first.

Working with the menu and changing parameters

To gain access to the menu, hold down the **M** key for 3 seconds. Once in the menu, parameters for one label and two label applications can be set.

For the one label mode, Offset Stop and Time Move Motor values can be set.

For the two label mode, label gap size, distance between labels, offset stop 1, offset stop 2 and Time Move Motor values can be set. Details can be found on page 16.

Labeling

The initial setup is done without a container installed. The new label should be just to the peeling edge. Offset-stop adjustments are made if necessary.

The labeling procedure is started by pressing the built-in 'Start' button, or by the external 'Start' pedal connected to the applicator. System status is indicated on the display. At the completion of label application, the label counter increases. Any time the start key is pressed for more than 3 seconds, the counter is reset.

Adjusting display contrast and brightness

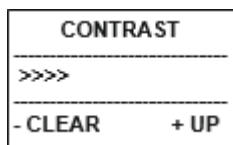

Press and hold the **▲** button for 3 seconds. The CONTRAST screen will appear. Press the **▲** button to increase the contrast level. Press the **C** button to decrease the contrast value. Press the **M** button to save the setting.

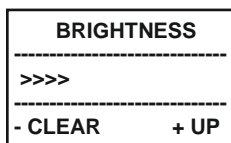

The BRIGHTNESS screen will now appear. Press the **▲** button to increase the contrast level. Press the **C** button to decrease the contrast value. Press the **M** button to save the setting.

Adjustment of the label sensor

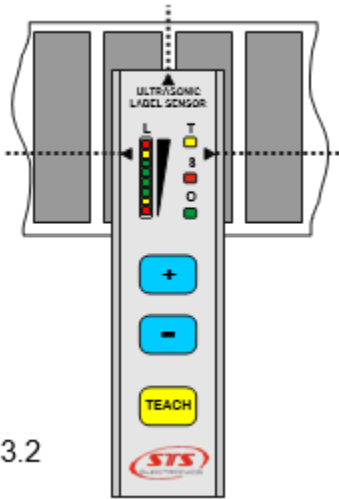

Figure 3.2

The label stock and matrix must travel through the sensor area. If irregular shaped label stock is used, the sensor will not register the gap correctly. When calibrating, the label stock cannot be moving.

1. Position the stock so that the gap is under the sensor, as shown in figure 3.2
2. Press and hold the TEACH button for 3 seconds. The yellow LED under T will be lit. When the button is released, the LED will be blinking. Sensor calibration takes place and the sensor level will be displayed on the LEDs under L. Once calibration is completed, the T LED will turn off.
3. Position the stock so a label is under the sensor, as shown in figure 3.3.
4. Press the TEACH button. The LED under T will turn on and will blink briefly. Sensor calibration takes place and the sensor level will be displayed on the LEDs under L.
5. If there is not enough signal difference between the label stock and the liner, the level LED indicators will blink, indicating an error. If this occurs repeat these steps again, with another section of the label material or try different label stock.
6. Exiting the error state can also be done by powering off the applicator.

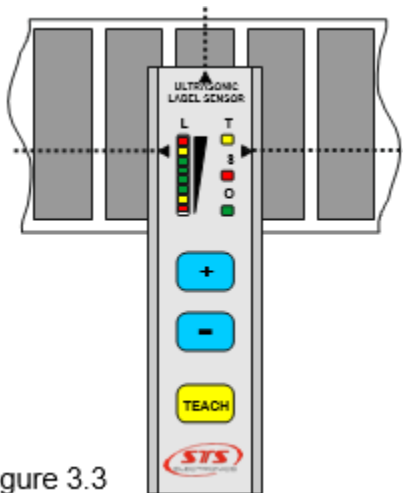

Figure 3.3

How to determine the Offset Stop value

This value needs to be determined when applying one label. The easiest way to do this is to use the online tool on our website, <https://afinialabel.com/calculate-a200>. This QR code will take you to the webpage.



To manually determine the value, follow these steps.

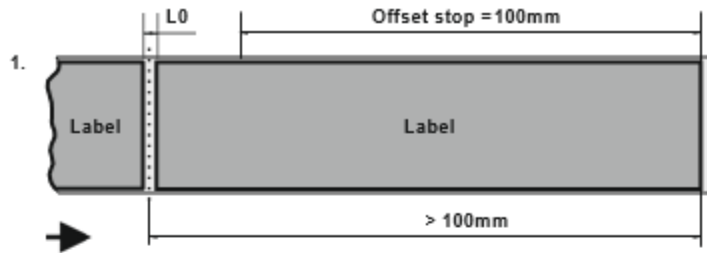

$L = 100\text{mm}$. This is the distance between the label sensor and the pooling edge.

1. If the length of the label being applied is larger than 100mm, the Offset Stop value will be 100mm.

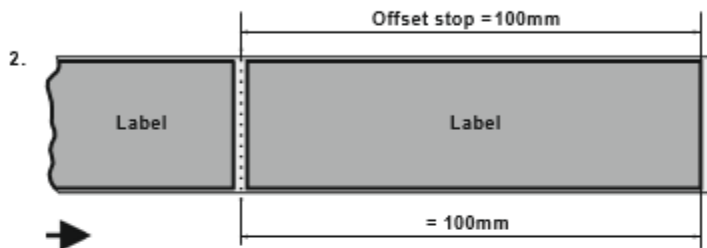

2. If the label length and half of the gap distance is equal to 100mm, then the offset stop value will be 100mm.

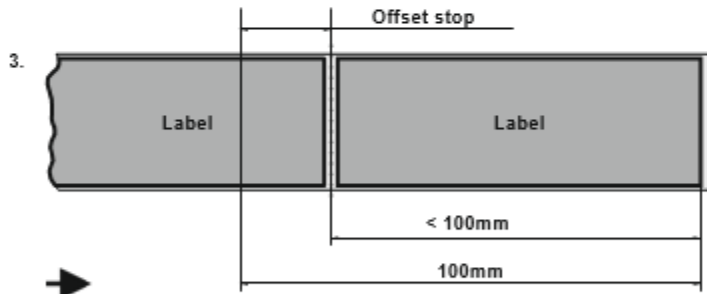

3. If the label length is less than 100mm, but larger than 50mm, measure the label size and half of the gap distance. Take that total and subtract it from 100mm. This will be the Offset Stop value.

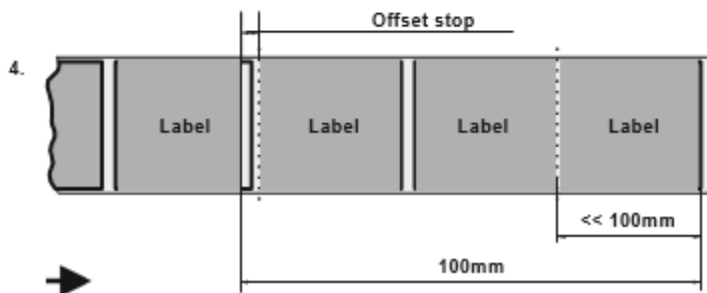

4. If the labels are much smaller than 100mm, measure the labels and gaps, adding the values to get as close to 100mm as possible. Subtract that number from 100mm. That is the Offset Stop value.

Figure 3.4.

How to determine the Offset Stop 1 value

This value determines the correct position of the back (2nd) label, when applying two labels to a container. The easiest way to do this is to use the online tool found on our website, <https://afinialabel.com/calculate-a200>. This QR code will take you to the webpage.



To manually determine the value, follow these steps.

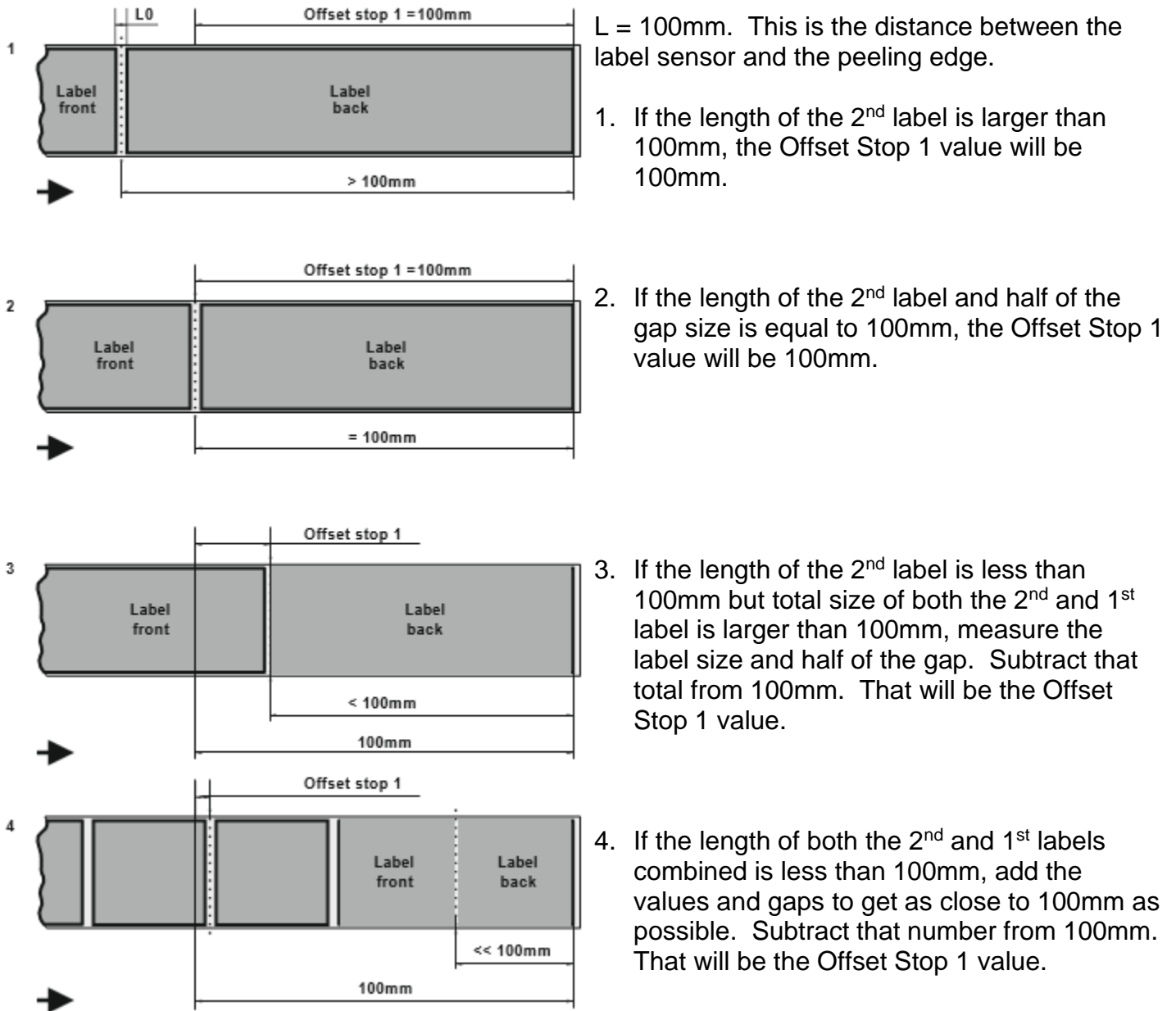

Figure 3.5

How to determine the Offset Stop 2 value

This value determines the correct position of the front (1st) label, when applying two labels to a container. The easiest way to do this is to use the online tool on our website, <https://afinialabel.com/calculate-a200>. This QR code will take you to the webpage.

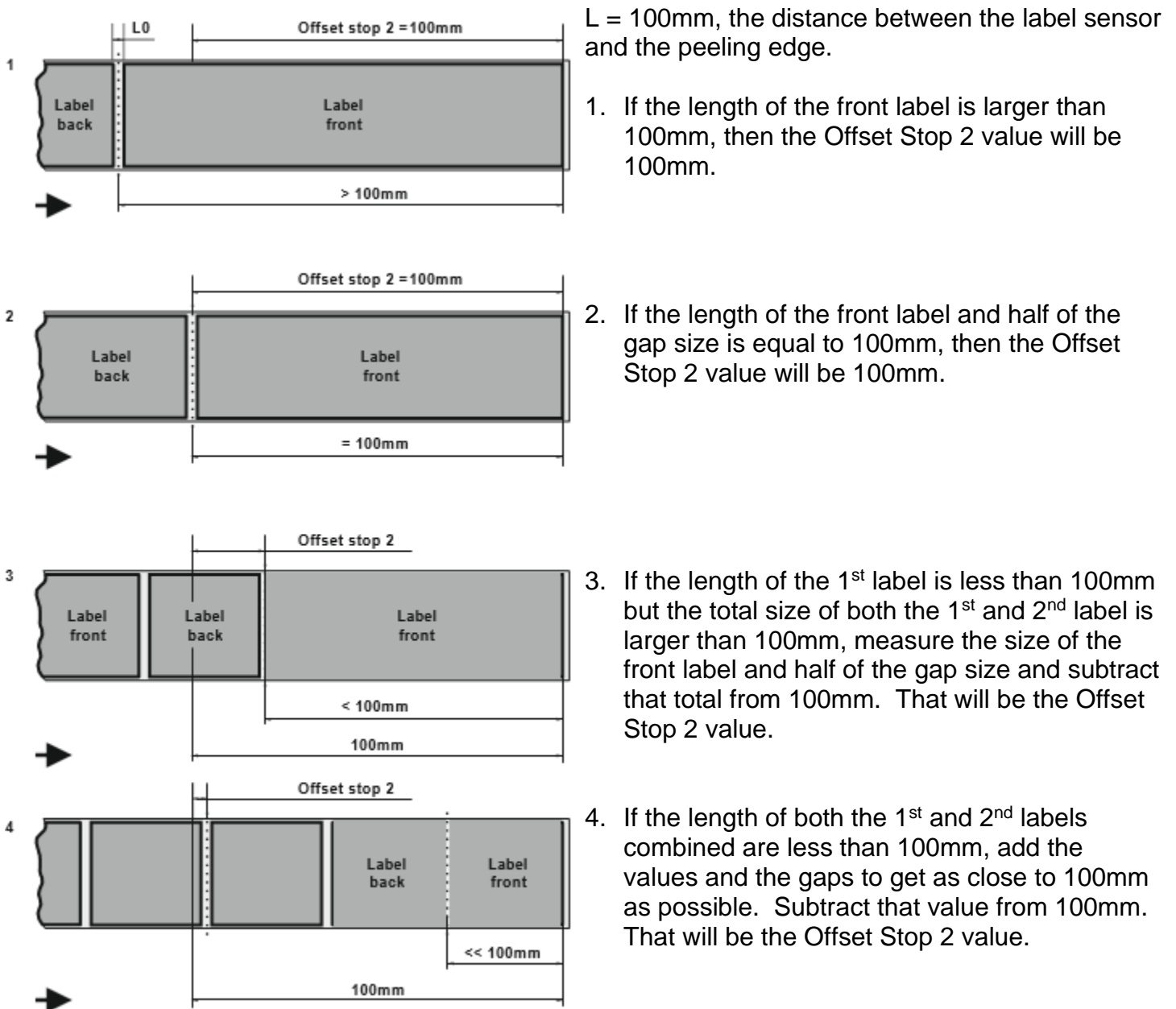

Figure 3.6

Memory Locations

There are 29 memory locations that can be used to store job parameters. Once a memory location is selected, enter in the job parameters, as described below. Once the parameters are saved, that memory location can be recalled, to run that particular job in the future.

To enter the memory location menu, press and hold the < button for 3 seconds.

SELECT PROGRAM

01

[00..29 program]

The select program menu will appear. Use the ^ and < buttons to change the values. Once the memory location is selected, press the M button.

SELECT PROGRAM



22

[00..29 program]

If recalling a previously saved job, select that memory location. If creating a new job, select an unused memory location and enter the values below.

NOTE: You will need to record which jobs are associated with each memory location. If you do not recall if a memory location has been used, you can select that location and press M to review the settings.

Working with the menu and changing parameters

To access the menu to change parameters, press and hold the  key for 3 seconds. The display will show the SELECT MODE menu. Use the  button to select the mode. Press the  button to enter that mode:

SELECT MODE

> ONE LABEL
TWO LABELS

ONE LABEL mode parameters

There are two parameters associated with the one label mode, Offset Stop and Time Move Motor. Refer to page 14 to manually determine the Offset Stop value. The Time Move Motor value is the amount of time the container will turn, to apply the label.





The easiest way to do this is to use the online tool found at this website: The easiest way to do this is to use the online tool on our website, <https://afinialabel.com/calculate-a200>. This QR code will take you to the webpage.







Once these numbers are determined, they can be entered into the applicator.

In the Select Mode menu, select ONE LABEL and press the {M} button. The Offset Stop menu will then appear:

OFFSET STOP
017 ^
[001 ... 999 mm]

Press  to change digit positions.
 Press  to change values.
 Press  to clear the value.
 Once the value is entered, press the  button.

TIME MOVE MOTOR
02.00 ^
[00.00 ... 60.00 s]

Next, the TIME MOVE MOTOR menu appears.
 Use the  button to change values.
 Use the  button to change digit positions.
 Use the  button to clear the value.
 Once the value is entered, press the  button.
 The main menu will now appear.

TWO LABEL mode parameters

There are five parameters associated with the two label mode, Labels Gap, Distance labels, Offset Stop 1, Offset Stop 2 and Time Move Motor.

Refer to pages 15 and 16 to manually determine the Offset Stop values. The Time Move Motor value is the amount of time the container will turn, to apply the label. The labels gap value is the size of the gap between labels. The distance labels is the distance between the application of the 1st label and the second label.

The easiest way to do this is to use the online tool found at this website: The easiest way to do this is to use the online tool on our website, <https://afinialabel.com/calculate-a200>. This QR code will take you to the webpage.



Once these numbers are determined, they can be entered into the applicator.

In the Select Mode menu, select TWO LABEL and press the {M} button. The Labels Gap menu will then appear:

LABELS GAP
03 ▲
[xx (mm)]

Press to change digit positions.
 Press to change values.
 Press to clear the value.
 Once the value is entered, press the button.

DISTANCE LABELS
01.17 ▲
[00.70...30.00 cm]

Press to change digit positions.
 Press to change values.
 Press to clear the value.
 Once the value is entered, press the button.

OFFSET STOP 1
017 ▲
[001 ... 999 mm]

Press to change digit positions.
 Press to change values.
 Press to clear the value.
 Once the value is entered, press the button.

OFFSET STOP 2
017 ▲
[001 ... 999 mm]

Press to change digit positions.
 Press to change values.
 Press to clear the value.
 Once the value is entered, press the button.

TIME MOVE MOTOR
02.00 ▲
[00.00 ... 60.00 s]

Press to change digit positions.
 Press to change values.
 Press to clear the value.
 Once the value is entered, press the button.

How to determine the distance between labels

When applying two labels, the distance between label one and label two needs to be entered into the applicator. The easiest way to do this is to use the online tool on our website, <https://afinialabel.com/calculate-a200>. This QR code will take you to the webpage.



To calculate this value manually, follow these steps.

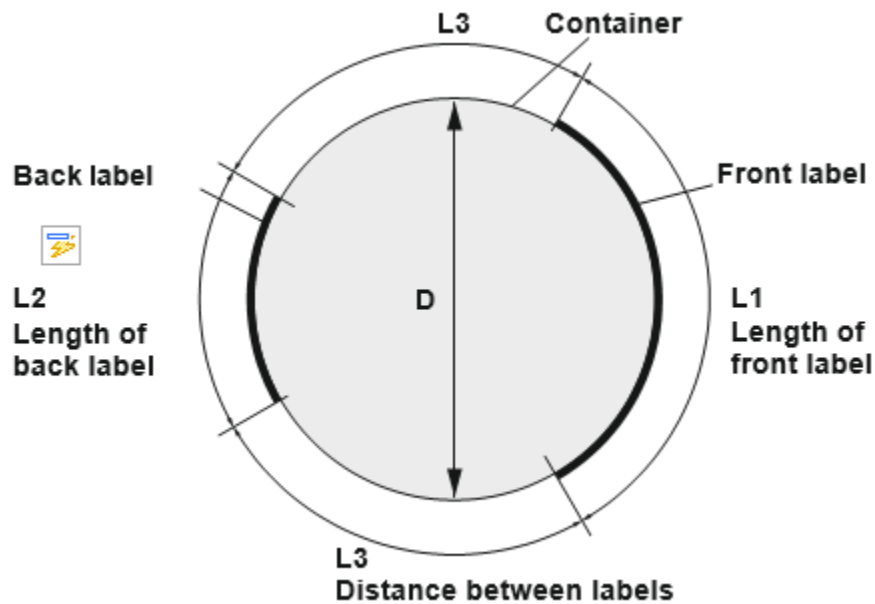

$L1$ = length of the front label (mm)
 $L2$ = length of the back label (mm)
 $L3$ = distance between the front and back label (cm)
 D = diameter of the container

$$L3 = ((D * 3.14 - L1 - L2) / 2) / 10 \quad [\text{cm}]$$

Example:

For a container with a diameter of 73mm, a front label size of 85mm, a back label size of 55mm, the distance between labels will be:

$$L3 = ((73 * 3.14 - 85 - 55) / 2) / 10 \text{ cm}$$

$$L3 = 4.461 \text{ cm}$$

The Distance Labels value entered in the parameters section would be 4.61.

Maintenance and cleaning

Attention! Risk of Injury!



- Always disconnect the power cable from the machine before performing any work on the device.
- The applicator does not require hardware maintenance for normal operation.
- Clean the machine after each job is completed.
- Use a brush or dry cloth to clean the machine. Do not use solvents to clean the exterior.
- Alcohol may be used to clean the shafts. Be careful not to let any liquids get into the machine.
- Make sure the vents do not get blocked.
- In the event of electrical shock, disconnect the power cable immediately and contact technical support.

Service

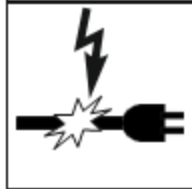

Attention:

- The machine should only be serviced by qualified personnel and only use original spare parts. This guarantees the safety of the machine.
- If the power cord is damaged, replace it with a new one. This ensures protection against electrical shock.

Transportation



Attention!

- When transporting this equipment, original packaging must be used, to avoid any damages.
- Avoid tilting or tipping the machine.
- Avoid any water exposure during transport.



Warranty

Below is the one-year limited warranty included with this Afinia product. Afinia prides itself on its outstanding product line and its technical support. If for some reason, your product fails, Afinia, a division of Microboards Technology, LLC, stands behind its warranties and assures you the best service possible in a quick and timely manner.

Afinia warrants to the original purchaser that this product is free from defects in material and workmanship.

Afinia will, for one year after warranty registration and at its option, repair or replace at no charge for parts and labor from the date you purchased the product from an authorized Afinia reseller. Consumables (i.e. printheads, ink cartridges, toner, drums, belts, maintenance modules) are covered by a DOA (Dead On Arrival) warranty upon installation.

- **Warranty registration must be completed within 30 days of receipt of the product in order to extend, at no charge, the standard 90-day limited warranty to one (1) year from date of purchase.**
- Afinia, a division of Microboards Technology, LLC, reserves the right to determine the validity of all warranty claims.
- Warranty is void if the product serial number has been altered or removed.
- Warranty is void if the product has been misused or damaged or if evidence is present that the product was altered, modified, or serviced by unauthorized service people.

The above stated warranty is exclusive and replaces all other warranties, express or implied, including those of merchantability and fitness for a particular purpose. Afinia, a division of Microboards Technology, LLC, will not be liable for any other damages or loss, including incidental or consequential damages and loss of profits or revenues from whatever cause, including breach of warranty or negligence.

This limited warranty is voided if the product fails to be properly maintained, or fails to function as a result of misuse. Misuse includes, but is not limited to, improper installation, neglect, duty cycle abuse, improper shipping, damage caused by disasters such as flood or fire, improper electrical current, and interaction with non-Afinia products. Damage caused by debris, contamination, or unauthorized service by anyone other than a Microboards authorized service center can result in the warranty being voided. Duty Cycle varies between product models. For specific duty limitations, call Afinia Technical Support at (952) 279-2643. This product has been thoroughly tested and inspected at the factory prior to shipment. Nevertheless, inspect your product completely for any damage or loss of parts that may have occurred during shipment. Notify the delivering carrier promptly if damage claims are to be filed.

Afinia reserves the right to modify or update its product without obligation to replace any equipment delivered prior to any such change.

For more information or technical assistance, contact Afinia Technical Support:

*support@afinia.com
952.279.2643*

Regulatory Details

FCC Statement

NOTE: This equipment has been tested and found to comply with the limits for a Class A digital device, pursuant to Part 15 of the FCC Rules. These limits are designed to provide reasonable protection against harmful interference when the equipment is operated in a commercial environment. This equipment generates, uses, and can radiate radio frequency energy and, if not installed and used in accordance with the instruction manual, may cause harmful interference to radio communications. Operation of this equipment in a residential area is likely to cause harmful interference in which case the user will be required to correct the interference at their own expense.

NOTE: Any changes or modifications to this equipment which are not expressly approved by the manufacturer could void the user's authority to operate this equipment.

CE Conformity

DIRECTIVE 2006/42 / EC, introduced by the Ordinance on Essential Requirements and Conformity Assessment of Machines

DIRECTIVE 2014/30 / EC, introduced by the Ordinance on Essential Requirements and Conformity Assessment for Electromagnetic Compatibility.

The product meets the requirements of the following harmonized standards:

BDS EN ISO 12100: 2011

Machine safety. General principles for design. Risk assessment and reduction risk (ISO 12100: 2010)

BDS EN 60204 - 1: 2006 + A1: 2009

Safety of machinery. Electrical equipment of machines. Part 1: General requirement.

BDS EN 61000-6-2: 2006

Electromagnetic compatibility (EMC). Part 6-2: Common standards. Resistance to interference with industrial environments.

BDS EN 61000-6-4: 2007 +A1: 2011

Electromagnetic compatibility (EMC). Part 6-4: Common standards. Radiation standard for industrial environments.



Technical Support

For technical questions or support issues, contact Afinia Label Technical Support:

US:
PH: 952-556-1608
support@afinia.com
www.afinialabel.com/support

UK:
PH: +44 (0) 845 250 7949
support@afinia.co.uk
www.afinialabel.com/support

Please have the Serial Number of your Afinia A200 Label Applicator available when contacting Technical Support.

Date of Purchase: _____

Place Purchased: _____

Serial Number: _____